

# Takara Belmont Barber Chair



## Luxury MAXIM

Model No. **AB-9500P/E**

# Operation Manual



Thank you for purchasing this Takara Belmont product. **Be sure to read this operation manual before operating the chair and always operate the chair properly according to the instructions herein.** Failure to read this operation manual may lead to accidents. This product is designed for commercial use in barber shops and beauty salons. Do not use this chair for any applications other than hairdressing/beauty-related procedures. Store this operation manual in a secure location and refer to it whenever necessary.

Use the "Book No." indicated on the back cover to request another copy of this manual from Takara Belmont if it becomes torn or damaged and unreadable, or is lost.

## Contents

**Safety Precautions (Must be Obeyed) 1**

**Use Precautions 6**

**Locations of Warning Labels 7**

**Precautions Related to Synthetic (Natural) Leather 7**

**Accessories 7**

**Name of Components 8**

**Preparation 10**

Power Supply 10

### How to Use

(1) Guiding Customers 12

(2) Raising/Lowering the Chair 14

(3) Reclining/Raising the Backrest 15

(4) Using Preset Functions 17

(5) Adjusting the Seat 19

(6) Using the Heater 20

(7) Using the Service Set 21

(8) Using the Dryer/Iron Holder 21

(9) Using the Service Outlets 22

(Models with the C-type plug only)

**Care and Maintenance 23**

**Daily Inspection 24**

**Before Requesting Repair 25**

**Daily Inspection Procedures 26**

**Specifications 28**

**Standard Period of Use 29**

**Disposing of this Product 29**

**Declaration of Conformity 29**



# Safety Precautions (Must be Obeyed)

## ■ Before Use



Be sure to thoroughly read these precautions related to safety and operate the chair accordingly in a safe manner.

## ■ User Prohibitions of this Product

Only persons who are certified hairdressers or beauticians can be allowed to use this chair.

## ■ About the Precautions Listed Here

The precautions described herein are in order to ensure safe use, to prevent any injury to users and other persons, and to prevent any damage. All these precautions describe important items related to safety. Be sure to always obey all the precautions contained in this manual. Takara Belmont has absolutely no responsibility for accidents that might be caused by failure to obey "Safety Precautions", "Use Precautions" and "Precautions Related to Synthetic (Natural) Leather" resulting in injury to users and other persons or other damage. In such cases, the responsibility for any injury and damage lies solely with the user who fails to obey "Safety Precautions", "Use Precautions" and "Precautions Related to Synthetic (Natural) Leather" and similar precautions. A detailed explanation of the cautionary symbols is provided below. Be sure that you fully understand their contents before reading the rest of this manual.

Classification of Precautions	Level of Harm and Damage, and Degree of Urgency
 <b>WARNING</b>	This indicates that failure to obey the corresponding warning and the resulting improper operation can result in death or serious injury.
 <b>CAUTION</b>	This indicates that failure to obey the corresponding warning and the resulting improper operation can result in mild injury, or moderate harm and damage.
<b>NOTE</b>	This indicates a recommended action that should be performed in order to ensure safety.

## **WARNING**

### Use a single outlet (do not share an outlet with other plugs)

Use an unshared outlet\* that has an attached ground terminal and matches the rated voltage and current of this product. Using the same outlet together with the power plug of other devices can result in abnormal heat generation and possible fire.  
\* 230 V AC (7 A or more)

### Be careful of power cord or plug breakage

Do not use any power cord or plug that is damaged, or that fits loosely when inserted into an outlet. Doing so can result in electric shock or fire.

### Unplug the power plug when the chair is not in use

Turn off the power switch and remove the power plug from the outlet when the chair is not in use. Unexpected operation can result in an accident or fire from a short circuit due to insulation aging.

### Securely connect to ground

Failure to make a ground connection can result in electric shock if there is a malfunction or short circuit. Consult an electrician for grounding procedures.

### Do not sit on the backrest of the chair

Sitting on the backrest of the chair could cause it to tip over, resulting in injury or damage.

### Do not disassemble or repair this product

Disassembly or repair must only be done by a qualified service staff. Disassembly by yourself can result in an accident, a malfunction, electric shock or fire.

# Safety Precautions (Must be Obeyed)

## WARNING

### Power cords must be replaced by a certified technician

Power cord replacement must be performed by the dealer, Takara Belmont staff, or a technician with equivalent certification.

### Consult an electrician for wiring work

Wiring work must be performed by certified personnel. Consult an electrician for wiring work.

### Firmly insert the power plug into the outlet

Be sure to fully insert the power plug into the outlet until reaching the base of the plug. Failure to fully insert the plug or a similar fault can result in a short circuit or heat generation that causes a fire.

### Be careful to keep the hands, fingers and other body parts of the customer and user from touching or getting close to moving parts

There is a danger of pinching and other physical injury.

### Hold by the power plug when unplugging

Do not pull the cord to remove the power plug from the outlet. Hold by the power plug at the end of the cord when removing. Removing the plug by pulling the power cord can damage the power cord, resulting in electric shock or fire.

### Do not wash the chair by pouring water on it

This chair is an electronic device. Do not sprinkle with water to clean it. Washing in such a manner can result in a malfunction or electric shock.

### Do not connect the earth (ground) to the following objects

- Water pipes  
Complete grounding is not possible as hard plastic pipes are widely used.
- Gas Pipes  
Connecting to gas pipes can result in an explosion or fire.
- Lightning rods and telephone dedicated grounding wire

### Installation precautions

- Installation of this chair must be performed by specialized personnel (personnel from Takara Belmont or Takara Belmont specified representative).
- The chair must be installed on a perfectly flat and solid floor.
- Installing the chair to a location with an angle of 5° or more can result in the chair tipping over.

### Do not use in an environment where there are electromagnetic interference waves

Using this chair in an environment where there are electromagnetic interference waves can cause faulty operation. Do not install the chair near equipment that generates electromagnetic waves such as communication equipment and elevators. Do not use devices that generate electromagnetic waves (such as mobile telephones) near this chair.

### Precautions when getting in and out of the chair

Always be sure to lower the chair to the lowest position and lock the rotation when a customer is getting in or out of the chair in order to ensure safety. Be especially careful when moving a person in a wheelchair in and out of the chair, and make sure that the wheelchair is not positioned in the operating range of the chair when moving the person. Feet, casters or other parts contacting the UP/DOWN pedal switch will cause sudden operation of the chair, resulting in injury or damage.

### Precautions for the surrounding area during chair operation

Before and during operation, thoroughly check that there are no bodies or limbs of persons, or possible obstacles in the operating range of the chair (ranges of seat raising/lowering, backrest reclining/raising, chair rotation, legrest operation) or nearby. There is a danger of body parts being pinched by the chair, resulting in injury or damage.

# Safety Precautions (Must be Obeyed)

## WARNING

### Precautions when changing the preset positions

- Before and while setting the preset positions, thoroughly check that there are no bodies or limbs of persons, or possible obstacles in the operating range of the chair or the area around the chair. There is a danger of body parts being pinched by the chair, resulting in injury or damage.
- When changing the legrest position, be very careful that the step or the customer's feet do not contact any nearby equipment or other items.

### Precautions after changing the preset positions

After changing the settings of preset positions, thoroughly check that there are no bodies or limbs of persons, or possible obstacles in the operating range of the chair or the area around the chair. There is a danger of body parts being pinched by the chair, resulting in injury or damage.

### Only sit in the area designated for such use

Never sit on the headrest, armrests, edge of the backrest, legrest, or the step, or subject these to an excessive (more than necessary) load or force with the backrest reclined. Doing so can result in the chair tipping over or being damaged.

### Do not stand on the edge of the step

Do not stand on the edge of the step. Doing so could cause the chair to tip over or the step could suddenly move, resulting in injury or damage.

### Precautions regarding customers and children

Be careful to closely watch customers (especially children) in order to make sure that they do not accidentally cause chair operation, resulting in an unexpected accident.

### Do not allow a customer to lie face down on the chair

Do not allow a customer to lie face down on the chair. Sudden operation of the chair can result in injury.

### Precautions when reclining/raising the backrest

- The space between the backrest and seat becomes narrow when the backrest is reclined. Check that the customer's hands, arms or clothes are not caught between the backrest and seat before reclining the backrest. There is a danger of body parts being pinched by the chair, resulting in injury.
- Carefully recline the backrest so that the headrest or backrest will not contact any shampoo bowl or nearby equipment.
- When you recline the backrest without using the headrest, support the customer's head with your hand so that the customer will not make contact with the shampoo bowl.
- Before raising the backrest, check that the customer's arms or hands are not in between the backrest and armrests, and operate it safely.

### Precautions during chair rotation

- Do not rotate the chair until you confirm that the customer has completely sat down in the chair.
- Always be sure that no other persons are in the surrounding area before rotating the chair, and rotate so that the step and other parts do not contact the customer or any nearby equipment. Be especially careful of the customer when the backrest is reclined and check that the safety of the customer is ensured before rotating the chair.
- Be sure to always lock (secure) chair rotation by using the rotation lock switch after rotating the chair. Always be sure that chair rotation is locked before moving the chair. There is a danger of injury or damage if the chair rotates suddenly.
- Always be sure to lock the chair when not rotating it.

### Procedures if a power outage occurs

- Turn off the power switch and remove the power plug of this product from the outlet in order to prevent unexpected operation when recovering from a power outage. Also turn off the power switches of all devices connected to the service outlet and remove the power plugs of devices.
- Be extremely careful if there is a power outage when the seat is in a high position such as for shampooing as it is not possible to lower the chair. Assist the customer in getting in and out of the chair in that position, being very careful that the customer is not injured and the chair does not tip over.

# Safety Precautions (Must be Obeyed)

## WARNING

### Precautions when raising or lowering the chair

Before raising or lowering the chair, always be sure to check that there are no persons or objects near the chair or step, under the armrest or in the gap of the support arm and so on. There is a danger of body parts being pinched, resulting in injury or damage.

### Precautions when using the heater

- The heater light is lit up in red when the heater is operating. Using the heater for an extended period causes the temperature to increase, possibly resulting in burns or fire. Be sure to turn off the heater switch when not necessary.
- Turn off the power and remove the power plug if you feel abnormal heat when touching the legrest, and contact your closest dealer or Takara Belmont.

### Precautions for the service outlets

- Be sure to fully insert the power plug of the device being used into the outlet until reaching the base of the plug. Failure to fully insert the plug or similar loose connection can result in a short circuit or heat generation that causes a fire.
- If the connection becomes loose, immediately stop using the device plugged into the service outlet, turn off the device power switch, and remove the power plug from the outlet. Also, stop using the chair, turn off the power, unplug the power plug, and contact your closest dealer or Takara Belmont.
- Remove the power plug of a device from the outlet when not using it.
- If any water gets on a service outlet, immediately turn off the chair power switch, remove the plug, and wipe away the water. Additionally, if a substantial amount of water gets inside a service outlet, immediately remove the plug and contact your closest dealer or Takara Belmont.
- Do not touch a service outlet with a wet hand.

### Precautions when using the table

Check that the table is securely inserted into the table securing slot before using the table. Failure to fully insert the table can result in the table falling off, causing injury and damage.

### Turn off the power switch and unplug the power plug before cleaning

Doing so can result in electric shock or fire. Also, sudden movement of the chair while cleaning can result in injury.

### Only persons who are certified hairdressers or beauticians can be allowed to use this chair

This product is designed for commercial use in barber shops and beauty salons.  
Only persons who are certified hairdressers or beauticians can be allowed to use this chair.

### Do not let children play with the chair

Do not let children play with the chair or stand on the backrest, armrests or other parts of the chair. Doing so can result in an accident or injury.

### Do not let children fix or clean the chair

Do not let a person unfamiliar with handling the chair (lack of experience and skills) such as children fix or clean the chair. Doing so can result in an accident or injury.

### Be sure to always perform daily inspection

Perform daily inspection according to the "Daily Inspection Procedures". Using the chair without performing daily inspection can result in malfunction or accident.

# Safety Precautions (Must be Obeyed)

## CAUTION

### Do not strongly strike or scrape the chair

Doing so can result in tearing of covers and similar damage, and faulty operation. In particular, striking or strongly pushing the plastic parts such as the backrest cover, the control panel, and the pump cover can result in deformation or breakage.

### Make sure that no feet or hands, or other objects will be pinched between the step and floor when raising/lowering or rotating the chair

### Turn off the power switch after you are finished using the chair

Turn off the power after use. Always operate the power switch by your hands only.

### Do not allow any person whose weight exceeds 135 kg/300 lb to sit in the chair

Doing so can cause the chair to tip over or faulty operation.

### Do not place any objects on top of the power cord

Do not place any objects on top of the power cord. Damage to the power cord can cause a severed wire or short circuit, resulting in electric shock or fire.

### Be careful that the power cord is not caught up by your feet or legs

### Before operation, confirm that every part is working normally and safely

Be constantly careful of and inspect for looseness, rattling, tilting, vibration, noise, odors and other possible problems. If you feel that something seems slightly different or not normal, immediately stop using the chair, and contact your closest dealer or Takara Belmont.

### Immediately wipe off any chemical solutions or water that spills on the chair

Chemical solutions can become a stain, and their adhering to an electrical part can cause faulty operation or short circuit. Immediately wipe off any grime or other foreign material that has adhered to the chair by using a dry soft cloth.

### Be extremely careful not to mistake the switches when operating.

The person operating the chair must pay careful attention to the surrounding area and give verbal warning and not mistake the operation of the chair.

### Precautions when using the dryer/iron holder

- Be careful that the dryer or iron does not contact the legs or other body parts of the customer when using the dryer/iron holder.
- Always be sure to store the holder under the body after use so it does not interfere with work.
- Do not rotate the dryer/iron holder with a hand dryer or iron still inserted in the slot. Doing so can damage the chair, and the heat can cause deformation or other damage.
- The dryer/iron holder can withstand a load of up to 50 N (5 kgf/11.2 lbf).

### Precautions for cleaning procedures

- Do not use any of the following substances to clean the chair.  
Thinner, alcohol, nail polish remover, volatile chemicals (such as gasoline or kerosene), acid or alkaline solutions, chlorinated cleaners, disinfectants that are highly corrosive to metal, povidone iodine (iodine solution), sodium hypochlorite, waxes containing abrasive compounds, sponges containing abrasive compounds, and similar substances.
- Do not use brushes, scouring brushes or similar items when cleaning the chair. Using them will damage the chair or result in the inability to clean off the dirt or grime.
- The metal and mechanical parts of the chair have sharp edges. Be careful when cleaning the chair that your hands, fingers or other body parts are not injured.

### Observe the following precautions when tilting the seat

- Do not raise the seat with the backrest reclined.
- Make sure the chair is properly adjusted for children before letting a child sit on it.

### Precautions when operating the headrest

Be careful when operating the headrest that fingers and other body parts are not pinched between the area around the headrest operation lever or between the headrest and backrest.

# Safety Precautions (Must be Obeyed)

## CAUTION

**Do not pull up the headrest more than necessary**

Be careful not to pull up the headrest more than necessary because doing so will make the headrest come off the chair.

**Precautions when using the cape holder**

- Do not apply excessive force to the cape holder as it can only withstand a load of 10 N (1 kgf/2.2 lbf).
- Be sure to always return it to the stored state when not in use.
- When storing the cape holder, be careful not to pinch the customer's or user's fingers between it and the armrest.
- When using or storing the cape holder, hold and rotate it until it reaches its final position.

**Unplug the power plug during installation of the chair and parts replacement**

Unplug the power plug from the outlet during installation of the chair and parts replacement. Doing so can result in an accident or injury.

# Use Precautions

## CAUTION

**Immediately wipe off any chemicals that spill on the chair**

Immediately wipe off any chemicals adhering to the leather or pump cover.

**Do not place any objects other than persons in the seat**

Do not place any objects other than persons in the seat. Doing so can result in deformation or tearing of the leather, or corrosion.

**Do not apply heat**

Do not apply heat to the chair. Doing so can result in deformation or discoloration.

**Recline the backrest at the end of the day**

When you have finished working for the day, lower the chair to the lowest position and completely recline the backrest. This helps to extend the service life of the chair by not applying a load to springs and cylinders.

## NOTE





The maximum load of this chair is 1,350 N (135 kgf/300 lbf). The raising speed of the seat declines as the maximum load is approached.

Contact your closest dealer or Takara Belmont if the breaker function (p. 25) frequently operates.

Be sure to keep a copy of the operation manual where these precautions are described.



# Locations of Warning Labels

⚠ WARNING	⚠ WARNING	⚠ WARNING	⚠ WARNING
			
Risk of pinching during the operation. Check the space below and around the chair when raising or lowering the chair and the legrest.	Risk of dropping of the pump. Carry the chair with holding the base and the foot switch.	Risk of malfunction or a fire caused by a short circuit. Unplug the power cord when not used.	Risk of electric shock, fire, and abnormal motion. Do not disassemble, repair or modify.
Refer to the Operation Manual for other notes.			



## Precautions Related to Synthetic (Natural) Leather

- Clothing dye adhering  
The color of clothing or belts can be transferred to the synthetic leather of this chair by means of contact. If color adheres to the leather, wipe off the stain as soon as possible by using a soft cloth that has been dabbed with a neutral detergent diluted with water to approximately 10% in order to prevent the stain from soaking in due to the plasticizer. Wipe the area with a dry cloth after wiping off the color.
- Precautions regarding deformation and color transfer due to contact
  - Contact with other plastic parts, painted items, solvents, adhesive tape and similar items can result in changes in surface luster, cracking, deformation and peeling.
  - Contact with newspaper or other printed items can result in color transfer.
  - Contact with printed clothing such as t-shirts, jeans and similar items can result in color transfer such as by dye adhering to the leather.
  - Contact with benzene, nail polish remover, alcohol and similar substances can result in discoloration, surface or plasticizer dissolution, changes in luster, hardening or softening, or peeling.
  - Use of bleach, or use of a sheet or other cloth for which bleach has been used can result in changes in luster and color.
  - Placement of an iron, heater or other excessive heat source near the chair can result in deformation and discoloration.
  - Use a curtain or similar item to block the chair from exposure to direct sunlight. Exposure to direct sunlight can result in surface deformation, shrinking, discoloration, faded colors and similar problems.
  - Placement of a heavy item for an extended period can result in marks or wrinkles that do not disappear after removing the item.

## Accessories

- Operation manual (this manual)
- Installation manual
- Rubber ring

# Name of Components

## ■ Main Unit

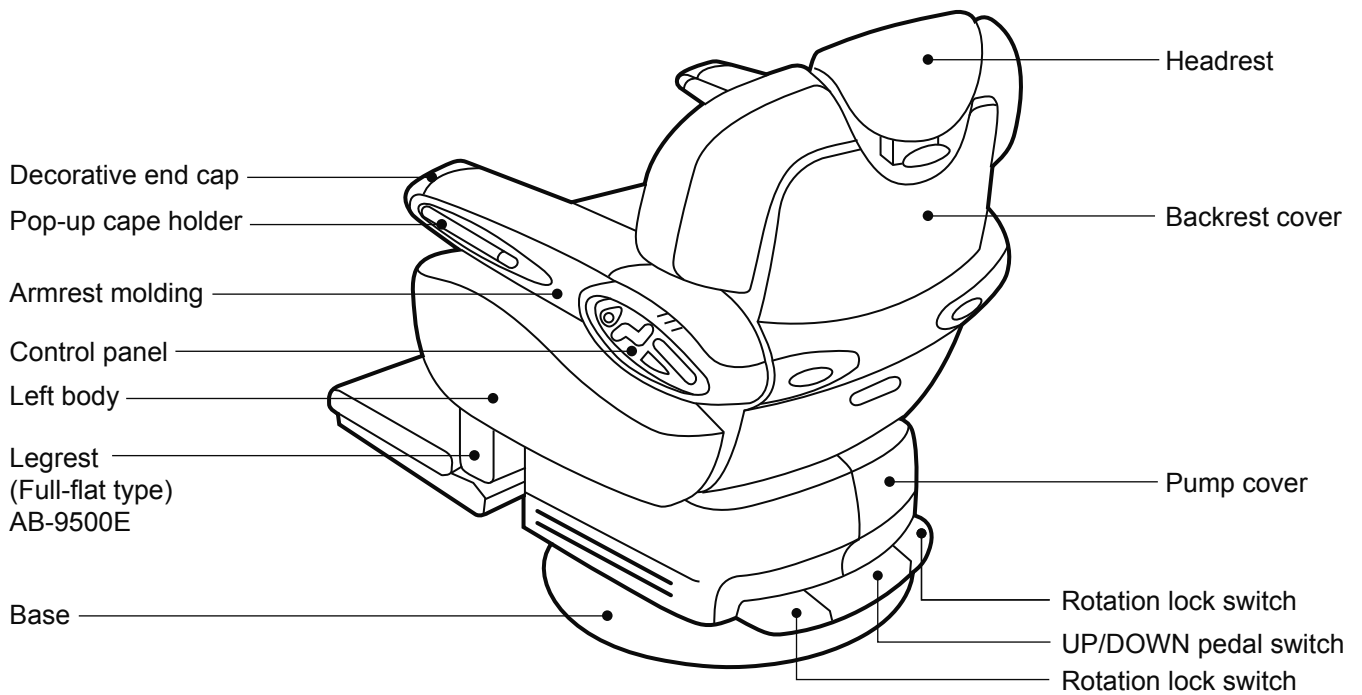
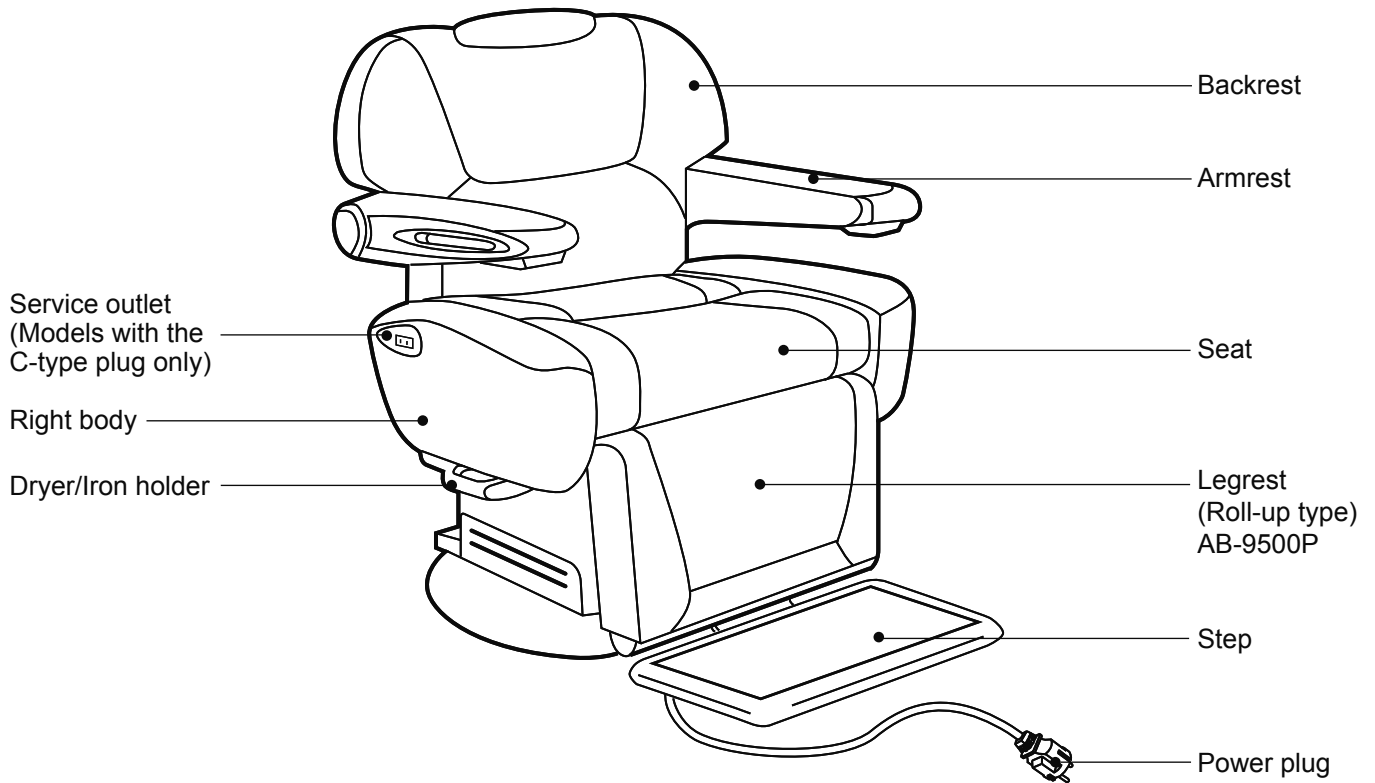

# Name of Components

## Operating Section

### Control panel

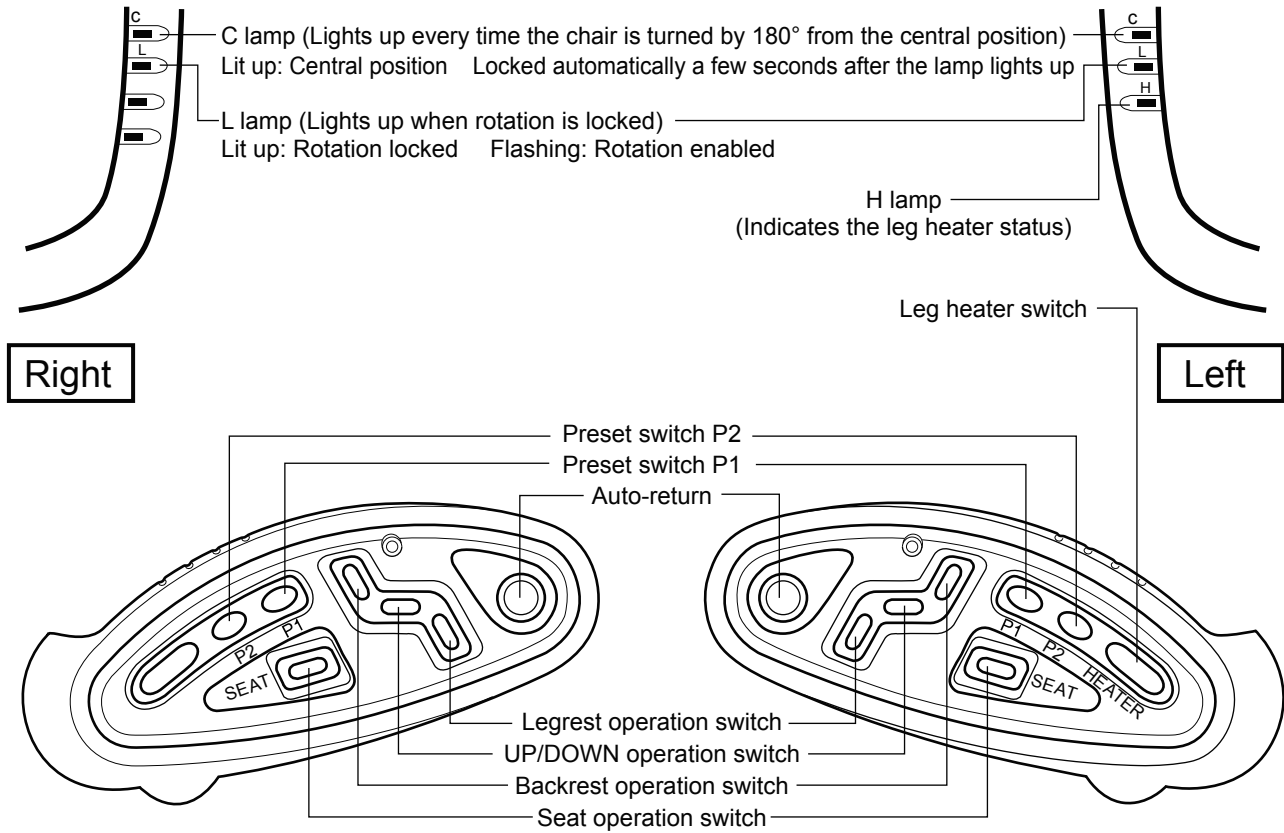

### Base Operation Section

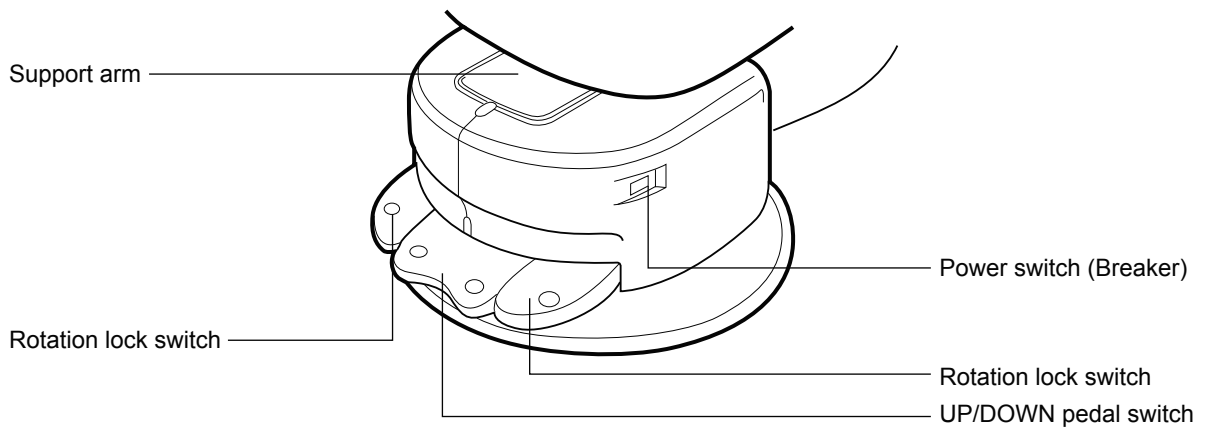

# Preparation

## Power Supply

### 1. Insert the power plug into the outlet

- Be sure to fully insert the power plug into the outlet until reaching the base of the plug. Failure to fully insert the plug or a similar fault can result in a short circuit or heat generation that causes a fire.
  - Do not pull the cord to remove the power plug from the outlet. Hold by the power plug at the end of the cord when removing. Removing the plug by pulling the power cord can damage the power cord, resulting in electric shock or fire.
  - Power cord replacement must be performed by the dealer, Takara Belmont staff, or a technician with equivalent certification.
  - Use an unshared outlet\* that has an attached ground terminal and matches the rated voltage and current of this product. Using the same outlet together with the power plug of other devices can result in abnormal heat generation and possible fire.
- \* 230 V AC (7 A or more)
- Wiring work must be performed by certified personnel. Consult an electrician for wiring work.
  - Do not connect the earth (ground) to the following objects.
    - Water pipes  
Complete grounding is not possible as hard plastic pipes are widely used.
    - Gas Pipes  
Connecting to gas pipes can result in an explosion or fire.
    - Lightning rods and telephone dedicated grounding wire
  - Failure to make a ground connection can result in electric shock if there is a malfunction or short circuit. Consult an electrician for grounding procedures.

#### WARNING

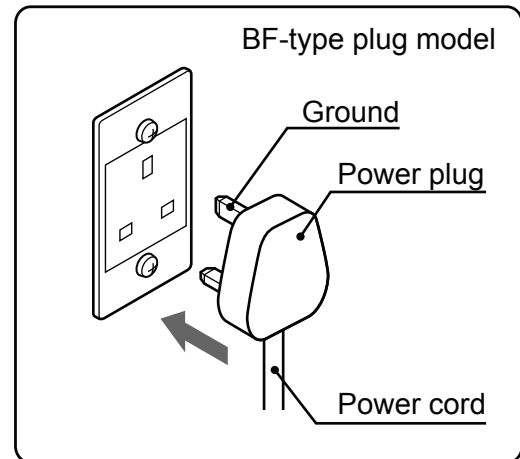
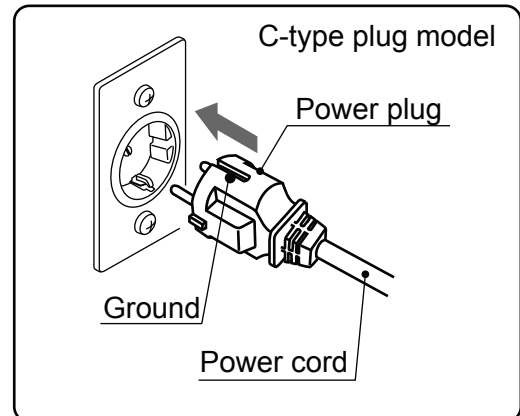

# Preparation

## 2. Turn on the power

Press the side with the **|** mark to turn the power on.  
Press the side with the **⊙** mark to turn the power off.

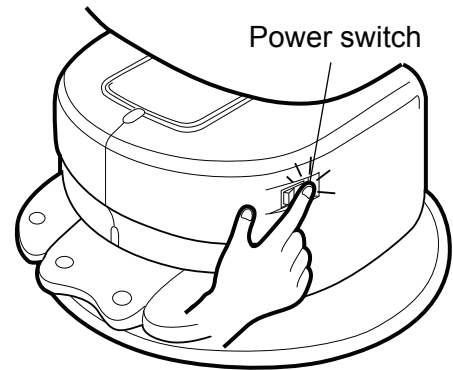
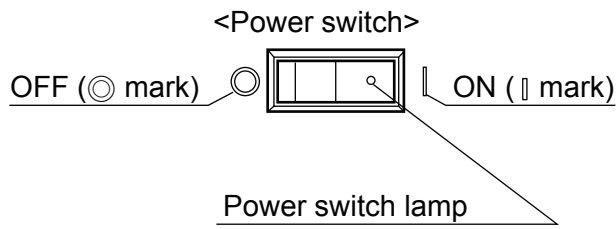

\*When the power is turned on with the chair rotation lock released, the chair rotation gets locked automatically.

### WARNING

Turn off the power switch and remove the power plug from the outlet when the chair is not in use. Unexpected operation can result in an accident or fire from a short circuit due to insulation aging.

### CAUTION

- Turn off the power after use. Always operate the power switch by your hands only.
- Immediately wipe off any medicinal solution or water that has adhered to the product by using a dry soft cloth or similar item. Chemical solutions can become a stain, and their adhering to an electrical part can cause faulty operation or short circuit.

# How to Use

## (1) Guiding Customers

### 1. Rotate the chair so that the customer can be easily seated on the chair

#### 1 Release the rotation lock

Press the rotation lock switch to release the lock and enable rotation of the chair.

(Operation is the same with the rotation lock switch on either side.)

The chair lock switch is operated by a hydraulic system.

The rotation lock repeatedly alternates between locked and released each time that the rotation lock switch is stepped on.

Rotation lock disengaged: The L lamp on the control panel flashes.

Rotation lock engaged: The L lamp on the control panel lights up.

This function does not work when the power is switched off.

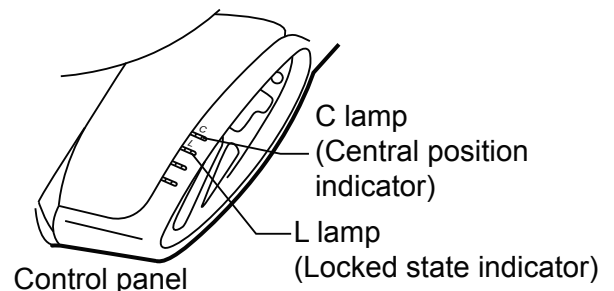
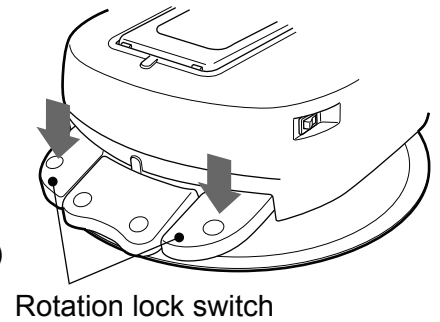

#### 2 Rotate the chair.

Hold the backrest or armrests when rotating the chair. You can rotate the chair a full 360°.

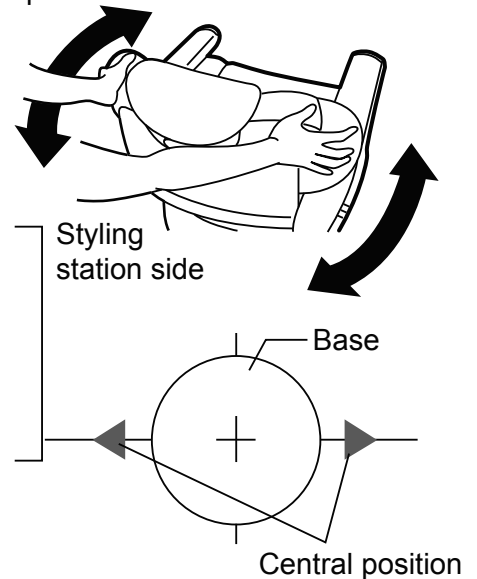

#### 3 Fix the chair in a work position.

Stop the chair at the desired work position and press the rotation lock switch at the foot controller. The chair is locked and prevented from rotating.

#### Automatic rotation lock function

This chair is equipped with a function that automatically locks it when you rotate it towards the front of the hair styling station. (Refer to the diagram that shows a 180° rotation interval with the base in the center.)

1 The C lamp on the control panel lights up when the frontal position of the chair is detected.

2 The chair is automatically locked a few seconds after the C lamp on the control panel lights up.

(The L lamp stops flashing and remains lit.)

3 To release the lock, press the rotation lock switch.

### WARNING

- Always be sure to lower the chair to the lowest position and lock the rotation when a customer is getting in or out of the chair in order to ensure safety.
- Do not rotate the chair until you confirm that the customer has completely sat down in the chair.
- Always be sure that no other persons are in the surrounding area before rotating the chair, and rotate so that the step and other parts do not contact the customer or any nearby equipment. Be especially careful of the customer when the backrest is reclined and check that the safety of the customer is ensured before rotating the chair.
- Be sure to always lock (secure) chair rotation by using the rotation lock switch after rotating the chair. Always be sure that chair rotation is locked before moving the chair. There is a danger of injury or damage if the chair rotates suddenly.
- Always be sure to lock the chair when not rotating it.

# How to Use

## 2. Using the cape holder

Using the cape holder:

- Provides space between the customer and the cutting cape to provide good ventilation.
- Makes it easy to clean up the cut off hair.

1 Reach below the front of the cape holder, and gently push it upwards to eject it to the side.

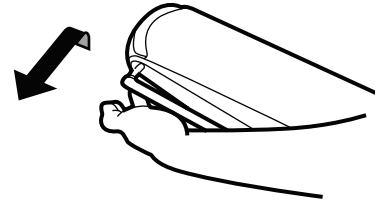

2 Rotate the ejected cape holder forward.

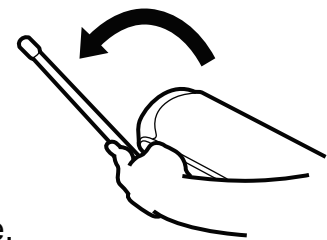

3 Pull out the tip of the cape holder and pinch the cutting cape.

(1) Pull from the top of the hair cutting cape. (2) Pinch the cape holder and release.

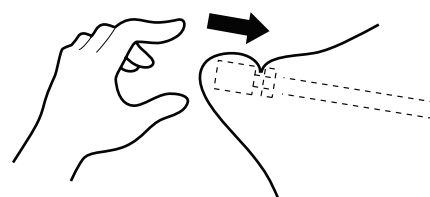
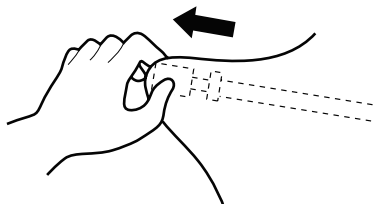

4 Rotate the cape holder rearward to store it.

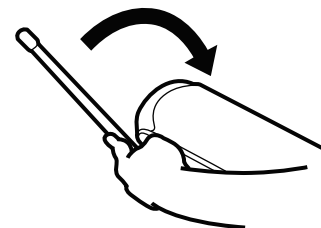

5 Push the front of the cape holder from above to insert it into the armrest.

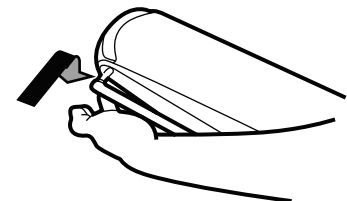

### CAUTION

- Do not apply excessive force to the cape holder as it can only withstand a load of 10 N (1 kgf/2.2 lbf).
- Be sure to always return it to the stored state when not in use.
- When storing the cape holder, be careful not to pinch the customer's or user's fingers between it and the armrest.
- When using or storing the cape holder, hold and rotate it until it reaches its final position.

# How to Use

## (2) Raising/Lowering the Chair

### 1. Raising the chair

To raise the chair, step on the right side of the UP/DOWN pedal switch or press the UP/DOWN operation switch upwards.

The chair operates while you are stepping on (pressing) the switch.

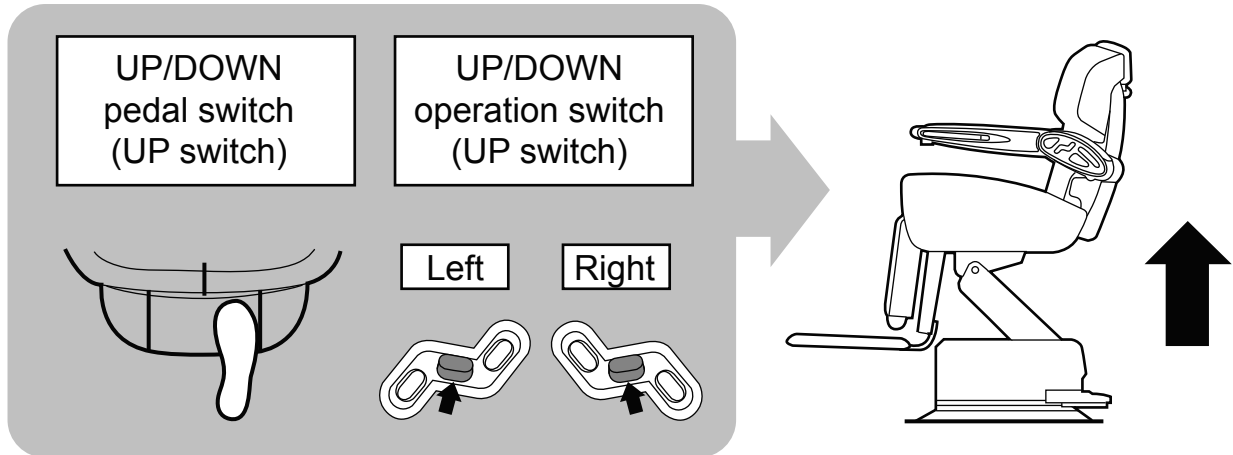

### 2. Lowering the chair

To lower the chair, step on the left side of the UP/DOWN pedal switch or press the UP/DOWN operation switch downwards.

The chair operates while you are stepping on (pressing) the switch.

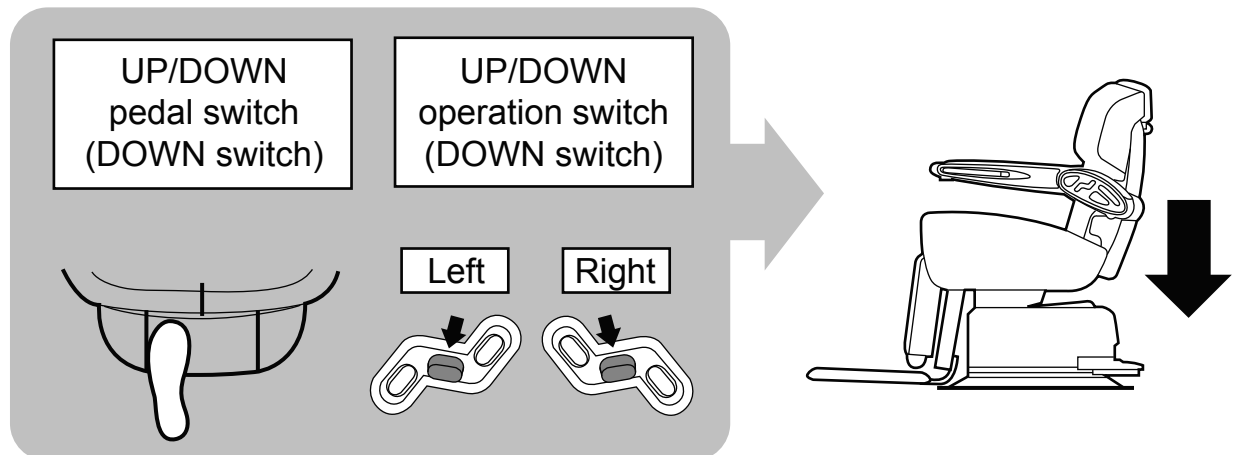

#### WARNING

- Before raising or lowering the chair, always be sure to check that there are no persons or objects near the chair or step, or in the gap of the support arm. There is a danger of body parts being pinched, resulting in injury or damage.
- This chair moves backwards as it is raised. Thoroughly check that there are no obstacles in front of or behind the chair.



# How to Use

## (3) Reclining/Raising the Backrest

### 1. Pulling out the headrest

Do not use the headrest if it is not needed, such as for back shampooing.

- 1 Lift up the headrest operation lever and pull out the headrest.

You can stop in any position.

Headrest rotation lock button

Headrest operation lever

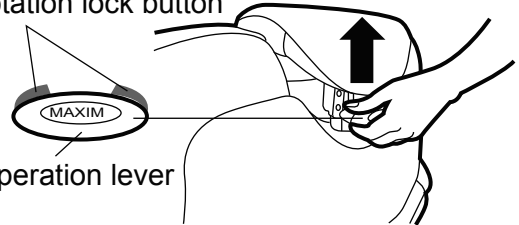

- 2 Hold the headrest, and rotate it in a position that is suitable for the customer.

Rotate the headrest until you feel it click. The headrest position is now locked.

Make sure the headrest position is locked before you let a customer lie down.



Locked state position

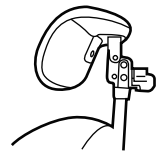

- 3 To return the chair to its original position after finishing work

- (1) Keep the headrest rotation lock button pressed, and hold the headrest operation lever.

- (2) Next, raise the headrest, push it all the way back towards the backrest to store it.

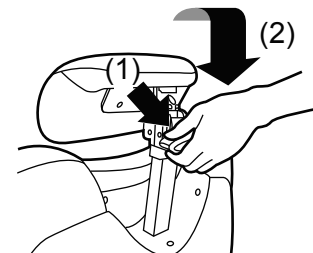

### ⚠ CAUTION

- Never use the headrest without its rotation lock engaged. A customer may be injured if the headrest accidentally rotates during shaving or similar work.
- Check that there are no impediments in the surrounding area when rotating the seat with the headrest pulled out.
- If the headrest comes off, press and hold the headrest rotation lock button, and insert the headrest in its original position.

### 2. Reclining the backrest

Push the backrest operation switch on the control panel (right or left) in the direction of the arrow to recline the backrest.

Backrest operation switch

Left

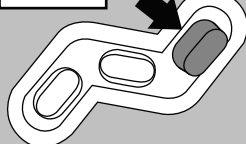

Right

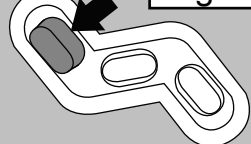

The chair operates while the switch is pressed.

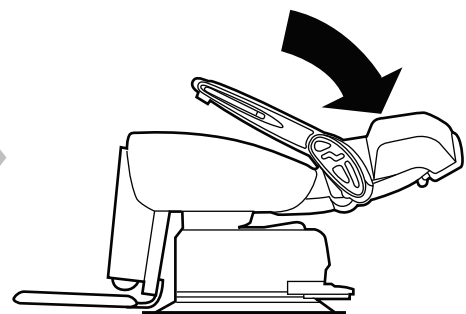

\*If the chair rotation lock is released, the chair rotation is locked automatically when you press the switch.

### ⚠ WARNING

- The armrests on this chair move together with the backrest, which causes the gaps between those parts and the body to narrow when the chair is reclined.
- Being pinched between them may cause serious injuries.

# How to Use

## 3. Raising the legrest

Push the legrest operation switch on the control panel (right or left) in the direction of the arrow to raise the legrest.

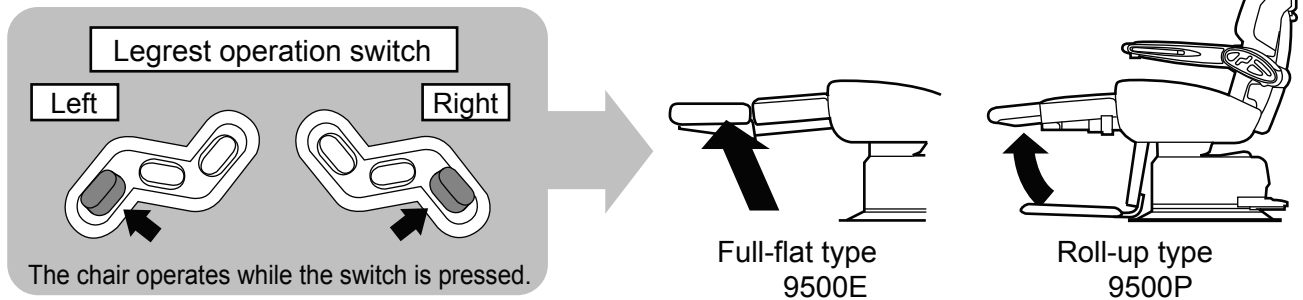

\*The roll-up type chair is equipped with a roll-up function that gradually extends the legrest forward as it is lifted.

**⚠ WARNING** Before raising the legrest, be very careful that the customer's feet will not contact any equipment in the front, and operate it safely.

## 4. Lowering the legrest

Push the legrest operation switch on the control panel (right or left) in the direction of the arrow to lower the legrest.

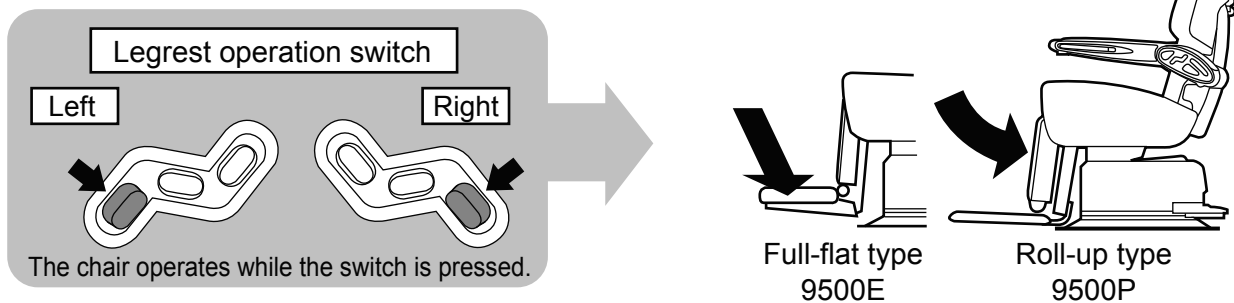

**⚠ WARNING** Before lowering the legrest, make sure that no persons or objects are under the legrest, and operate it safely.

## 5. Raising the backrest

Push the backrest operation switch on the control panel (right or left) in the direction of the arrow to raise the backrest.

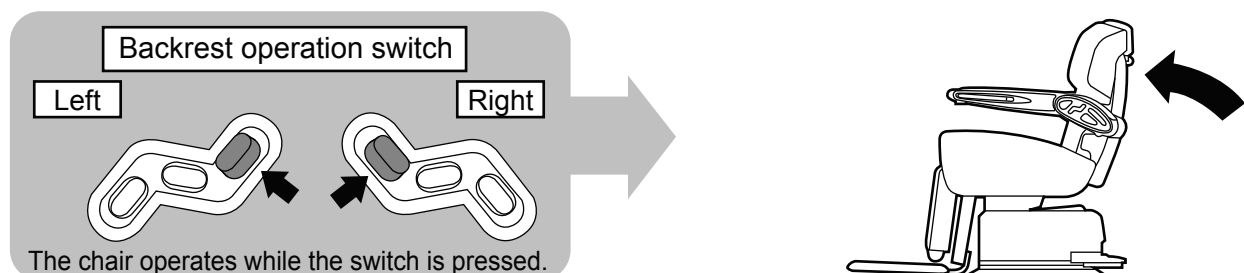

Use the preset function to move the chair to the preset position.  
Refer to "(4) Using Preset Functions" on p. 17.

## (4) Using Preset Functions

### 1. Using the preset function

**Preset Function** ⇒ This function allows you to simply press the switch once to make the chair rise automatically to its preset position and the backrest recline.

1. Pull the headrest out to the desired position beforehand if you need to use it.
2. Press the preset switch (indicating P1 or P2) on the control panel once. The chair moves to the previously set position.

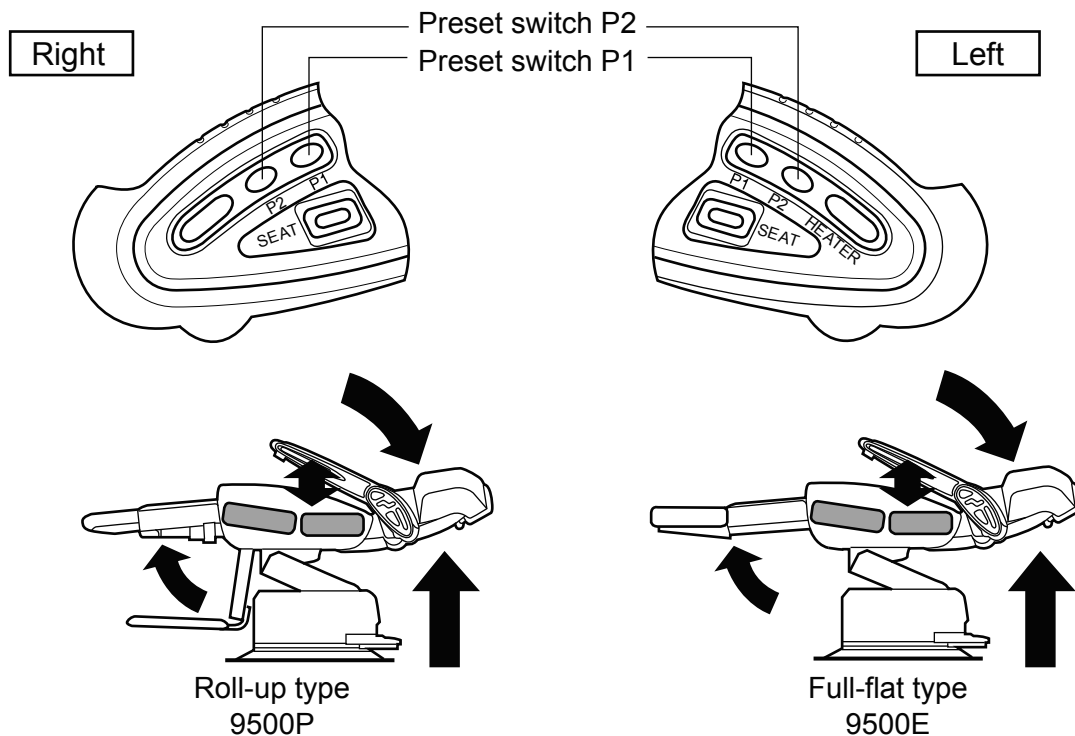

### <Changing Settings of the Preset Function>

Although the setting positions of the preset switches are previously set when shipped from the factory, you can change the settings to positions that match your customers. There are only two seat tilting positions available: the neutral position and the relaxation position. When shipped from the factory, the seat is set to the neutral position.

Perform the following procedures to change the preset positions.

- (1) Move the chair to the desired position.
- (2) Press and hold the preset switch for approximately three seconds until you hear an electronic beep indicating that the position is set.
- (3) Setting is completed when the electronic beep is emitted. Return the chair to its original position by using the auto-return switch, and use the preset switch for which you have changed the setting to make sure that the chair moves to the position you have set.

#### ⚠ CAUTION

- Be very careful when setting the position of the legrest so that the customer's leg will not contact any equipment or other items in the front.
- Perform position setting with a person sitting in the chair. The chair is equipped with a shockless device. Accordingly, the final operating position varies slightly if position setting is performed without a person sitting in the chair.
- The seat cannot be operated when it is placed above its neutral position.

# How to Use

## 2. Using the auto-return function

Press the auto-return switch on the control panel (right or left).

The chair height, backrest angle, legrest position, and seat position return to their original positions automatically.

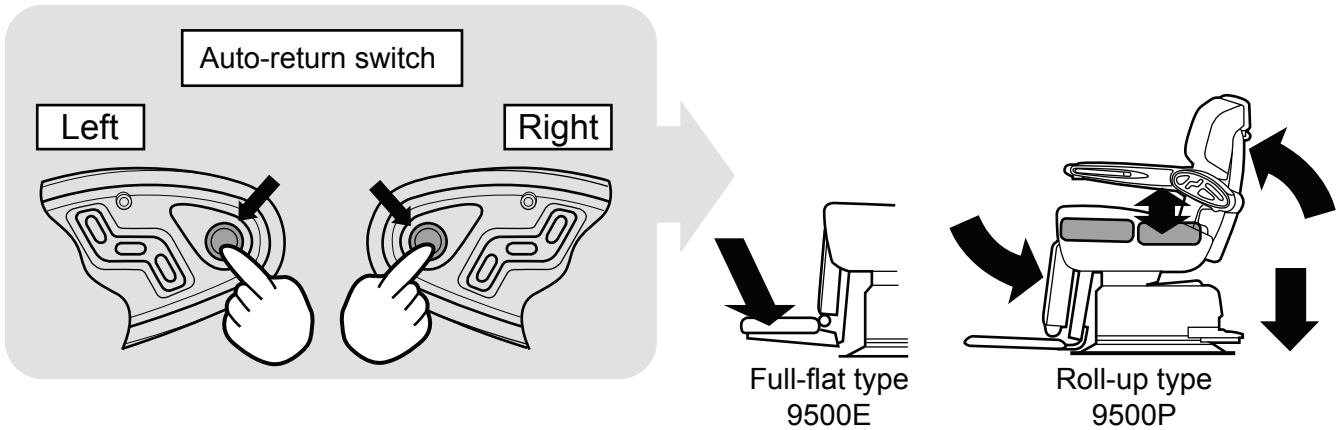

### <Changing Settings of the Auto-return Function>

The position set by the auto-return switch is already configured when the chair is shipped from the factory. The seat tilting position, on the other hand, can be set according to the customer's preferences either to the neutral or relaxation position. When the chair is shipped from the factory, the seat tilting position is set to neutral.

Perform the following procedures to change the preset positions.

- (1) Change the seat tilting position to either the neutral or relaxation position.
- (2) Press and hold the auto-return switch for approximately three seconds until you hear an electronic beep indicating that the position is set.
- (3) Setting is completed when the electronic beep is emitted. Use the seat operation switch to raise the seat, and then use the auto-return switch to confirm that the position has been set correctly.



**WARNING** Before using the auto-return function, make sure that no persons or animals are under the legrest or step or in the support arm area, and operate it safely.

## Cancel Function

Press any switch other than the vibration switch if you want to stop chair operation midway when using the preset or auto-return switches. The cancel function operates to stop chair operation.

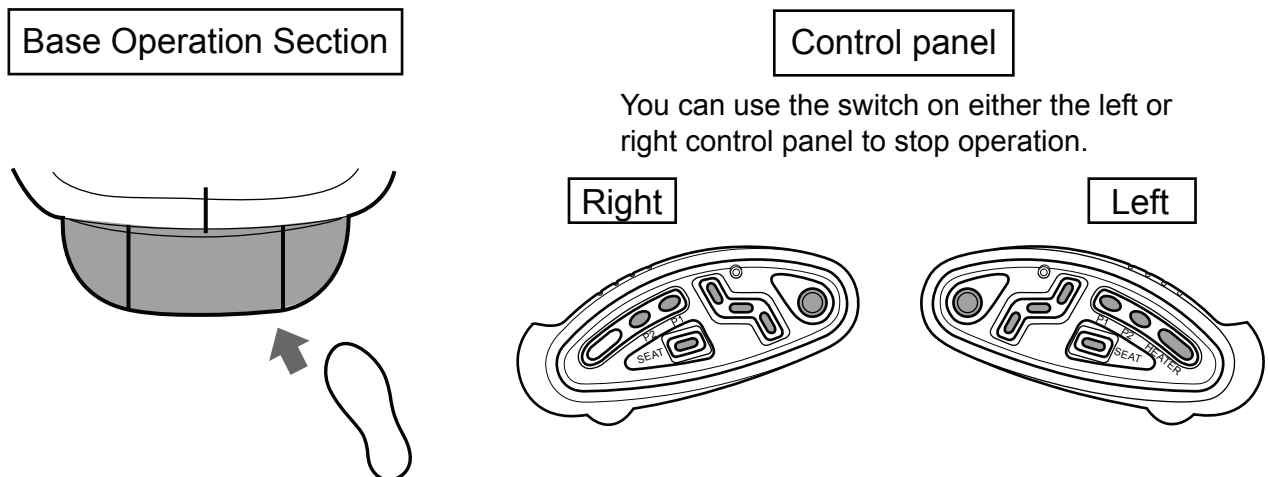

■ Pressing any of the switches shaded in gray will stop the operation.

# How to Use

## (5) Adjusting the Seat

This chair is equipped with a function that allows you to adjust only the seat section separately. Use this function to make the necessary adjustments.

Right

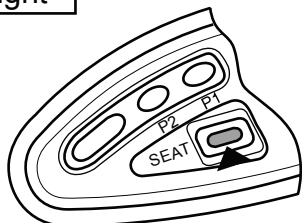

Left

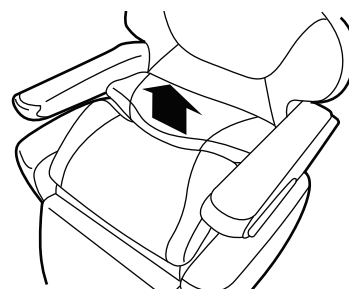
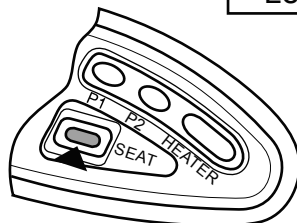

### Setting the seat position for children

Push the seat operation switch on the control panel upwards. The seat continues to rise as long as you hold the switch. The rear part of the seat is lifted horizontally, allowing you to set the chair to a position suitable for a child during cut and styling. If a child needs to use the legrest, you can adjust it by putting it in a horizontal position.

### Setting the front shampooing position

Push the seat operation switch on the control panel upwards. The seat continues to rise as long as you hold the switch. The front part of the seat tilts forward, allowing you to set the chair to the best position to provide treatment during front shampooing.

### Setting the relaxation seat position

Push the seat operation switch on the control panel downwards while the seat is in its initial (neutral) position. The seat continues to move down as long as you hold the switch, allowing you to set the relaxation seat position.

### Returning the seat to its initial (neutral) position

While the seat is raised above its initial position, push the seat operation switch on the control panel downwards once to lower the seat to its initial position automatically. The seat is designed to lower slowly in order to ensure safety. Use the "Cancel Function" (p. 18) to stop the seat while it is moving.

Side view of the seat  
Seat position for children

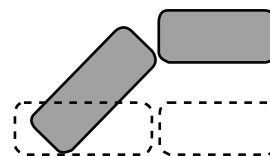

Front shampooing position

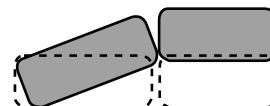

Relaxation seat position



Initial (neutral) position



Right

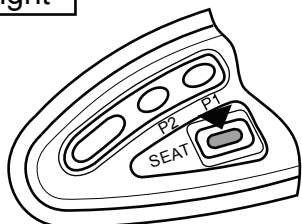

Left

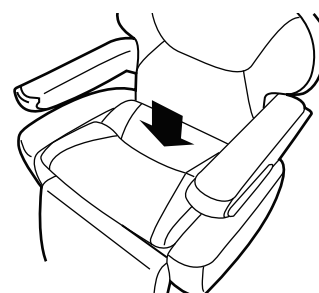
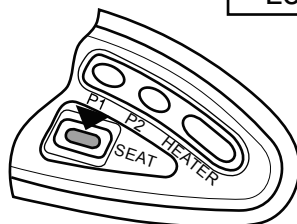

**CAUTION**

- Do not raise the seat with the backrest reclined.
- Do not raise or lower the seat while a child is seated. Only allow a child to sit down after setting the chair to an appropriate position.

# How to Use

## (6) Using the Heater

The legrest is equipped with a built-in heater. Use it when your customers need it.

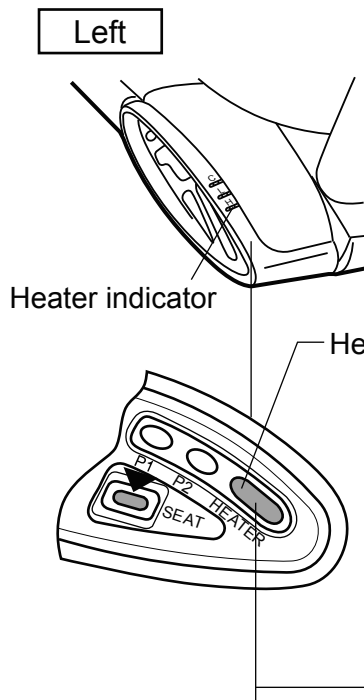

Press the heater switch ("HEATER") of the control panel on the left side once to activate the legrest heater. (The heater indicator turns on.) Press the same switch again once to turn the heater off. When the heater indicator is off, the heater is deactivated. When the heater is activated, the heater indicator turns red. Do not forget to turn the heater off when you no longer need it. The heater is turned off automatically when the chair is not in use. (After one hour)

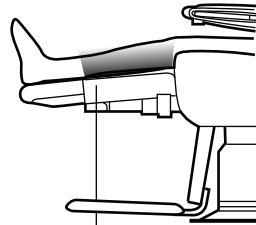

Roll-up type  
9500P

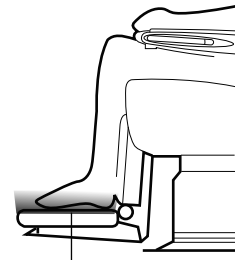

Full-flat type  
9500E

For the roll-up type chair, use the heater with the legrest raised because heat will escape and the effective temperature will be reduced if the customer's calves do not contact the legrest.

### WARNING

- The heater light is lit up in red when the heater is operating. Using the heater for an extended period causes the temperature to increase, possibly resulting in burns or fire. Be sure to turn off the heater switch when not necessary.
- Turn off the power and remove the power plug if you feel abnormal heat when touching the legrest, and contact your closest dealer or Takara Belmont.

# How to Use

## (7) Using the Service Set (Optional)

Before starting work, insert the fixture side of the service table into the service table securing slot, and push it all the way in. The table is now ready.

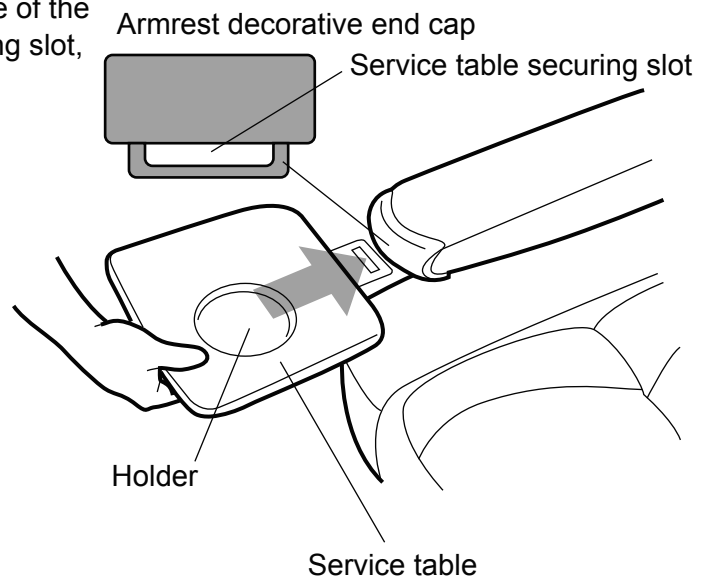

- Do not insert/remove the table or operate the chair with items on the table. Doing so can result in such items falling off or in spilling of liquids.
- Do not place objects that exceed 20 N (2 kgf/4.5 lbf) on the table, or items that hang over or extend beyond the table surface. Doing so can result in damage to or deformation of the chair or table.
- Do not use the cape holder when using the table. Doing so can result in damage to or deformation of the cape holder or table.
- Be careful that nearby devices such as the shampoo bowl do not interfere with the table when rotating or operating the chair while using the table.



**CAUTION** Check that the table is securely inserted into the table securing slot before using the table. Failure to fully insert the table can result in the table falling off, causing injury and damage.

## (8) Using the Dryer/Iron Holder

Pull out the dryer/iron holder from the lower part of the body on the right side of the chair.

You can use this as a stand for a hand dryer or iron while working.

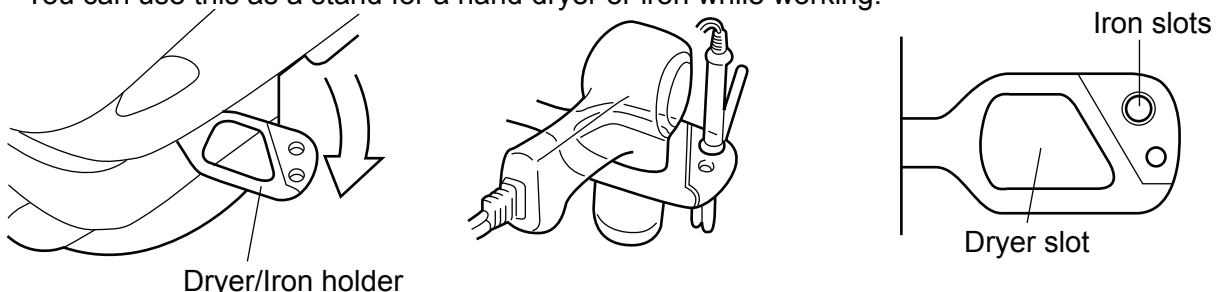

- Be careful that the dryer or iron does not contact the legs or other body parts of the user or customer when using the dryer/iron holder.
- Always be sure to return the holder to its original position after use so it does not interfere with work.
- Do not rotate the dryer/iron holder with an iron or hand dryer still inserted in the slot.
- Doing so can damage the body of the chair, and the heat can cause deformation or other damage.
- The dryer/iron holder can withstand a load of up to 50 N (5 kgf/11.2 lbf).

# How to Use

## (9) Using the Service Outlet (Models with the C-type plug only)

This chair is equipped with service outlet located in the right body section.

This chair is equipped with service outlet, located in the right body section.

Current available for use is 7 A (230V AC) or less when not operating the chair and 4A or less combined when operating the chair.

The power switch (breaker) on the right side of the base operation section is turned off if the current available for use is exceeded.

If this occurs, stop using the connected device(s), and turn on the power switch again.

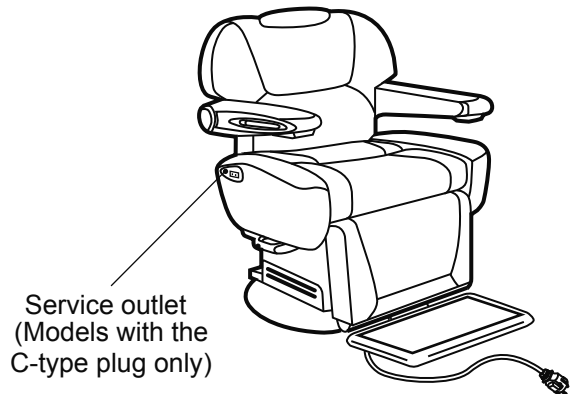

This chair is specially designed for commercial use in providing procedures and services of barber shops and beauty salons. It can only be used by trained hairdressers and beauticians, or by staff under the supervision of a trained hairdresser or beautician.

### Accumulator

This chair is equipped with an accumulator that reduces vibration during operation. The accumulator absorbs loads applied to the chair to provide shock-free performance. Accordingly, the following conditions might be observed.

- The stopping position of the chair might vary due to slowly stopping the chair in order to absorb shocks.
- The chair might seem to slightly bounce due to load changes when getting in or out of the chair, or during massage.
- The chair might rise slightly when a customer gets out of the chair.

(Due to the load applied to the customer being absorbed when a customer sits, causing the chair to sink.)

### WARNING

The power plug becomes hot and can result in fire if the power plug of a device using a service outlet is not firmly plugged in or there is a looseness inside the outlet when using the service outlet. Immediately stop using the device, turn off the device power switch, and remove the power plug from the service outlet. Also, stop using the chair, turn off the power, unplug the power plug, and contact your closest dealer or Takara Belmont.



# Care and Maintenance

Clean this chair after use to maintain it in a clean state. Leaving dirt or grime on the chair can result in the formation of mold. Always be sure to unplug the power plug from the outlet when cleaning the chair.

## ■ Cleaning of Each Part

### Leather Parts

Lightly wipe clean using a dry soft cloth.

**If extremely dirty**

Wipe clean with a soft cloth that has been dabbed with a neutral detergent diluted with water to approximately 10%. Wipe the area with a dry cloth after wiping off the color.

### Plastic Parts

Wipe clean using a dry soft cloth.

**If extremely dirty**

Wipe clean with a soft cloth that has been dabbed with a neutral detergent diluted with water to approximately 10%. Wipe the area with a dry cloth after wiping off the color.

### Operating Section Metal Parts

Wipe clean using a dry soft cloth.

Do not clean these parts with a wet cloth because they are readily affected by moisture and water. Wipe off all moisture immediately if any water gets on these parts. Water left on these parts will result in rust or malfunction of electronic parts.

### CAUTION

- Do not use any of the following substances to clean the chair. Thinner, alcohol, nail polish remover, volatile chemicals (such as gasoline or kerosene), acid or alkaline solutions, chlorinated cleaners, disinfectants that are highly corrosive to metal, povidone iodine (iodine solution), sodium hypochlorite, waxes containing abrasive compounds, sponges containing abrasive compounds, and similar substances.
- Do not use brushes, scouring brushes or similar items when cleaning the chair. Using them will damage the chair or result in the inability to clean off the dirt or grime.
- The metal and mechanical parts of the chair have sharp edges. Be careful when cleaning the chair that your hands, fingers or other body parts are not injured.

### WARNING

- This chair is an electronic device. Do not sprinkle with water to clean it. Washing in such a manner can result in a malfunction or electric shock.
- Turn off the power switch and unplug the power plug before cleaning or wiping down the chair. Doing so can result in electric shock or fire. Also, movement of the chair while cleaning or wiping down can result in injury.

### CAUTION

- Do not clean leather parts using a cleaner or bleach containing organic solvent or abrasive compounds. Such substances can cause the leather surface to deteriorate or dull the luster.
- If color from clothing, belt or similar item adheres to the leather, wipe off the stain as soon as possible by using a soft cloth that has been dabbed with a neutral detergent diluted with water to approximately 10% in order to prevent the stain from soaking in due to the plasticizer. Wipe the area with a dry cloth after wiping off the color.

To use a chair that has not been used for an extended period, clean before using and be sure to check that the chair operates safely without any error.

# Care and Maintenance

## ■ Spray-type Hairstyling Products (Especially hard types)

When using spray-type hairstyling products (especially hard types), check the entire chair to make sure that none of the product is adhering to the exterior surface of the chair (including leather parts). Immediately wipe off any hairstyling product that is adhering to the chair. Failure to wipe off the product and allowing it to remain result in the hairstyling product hardening, leaving a feeling of roughness. Be especially careful of flat surfaces (such as the plastic covers) as this roughness is considerably noticeable on flat surfaces.

### \*If hairstyling product has hardened:

Clean off adhered and hardened hair product by using ethanol.

However, repeatedly cleaning off product adhering to plastic covers and leather parts by using ethanol can cause the surface to deteriorate, the luster to be lost, and cracking. Immediately wiping off any adhering hairstyling product is the best method to prevent any problems of this type.

# Daily Inspection

Perform inspection according to the "Daily Inspection Procedures" indicated on pages 26 and 27 of this operation manual in order to ensure safe use of this chair.



### WARNING

Perform daily inspection according to the "Daily Inspection Procedures". Using the chair without performing daily inspection can result in malfunction or accident.

# Before Requesting Repair

If any of the problems described below occur, conduct the checks outlined before requesting repair.

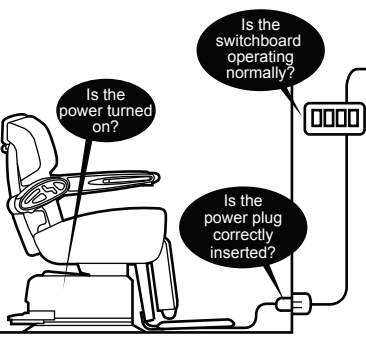
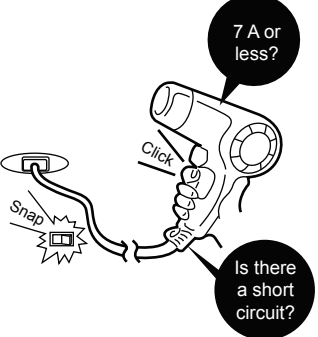
Problem	Check Points	Recovery Procedures
<p>■ Chair does not move.</p> 	<ul style="list-style-type: none"> <li>■ Is the power plug correctly inserted?</li> <li>■ Is the power switch turned on?</li> <li>■ Has a fuse of the shop's switchboard or breaker been tripped?</li> <li>■ Has the chair been continuously operated for an extended period?</li> </ul>	<ul style="list-style-type: none"> <li>■ Correctly insert the power plug. (p. 10)</li> <li>■ Turn on the power (p. 11).</li> <li>■ Replace the fuse of the switchboard or turn on the breaker.</li> <li>■ The problem is due to the operation of the overheating prevention device. ⇒ Leave the chair for approximately 10 min. to allow it to return to the normal condition.</li> </ul> <div style="border: 1px solid black; padding: 2px; width: fit-content; margin: 5px 0;">Overheating Prevention Device</div> <p>This is a protective circuit that prevents abnormal overheating of internal mechanisms due to continuous operation and similar causes. The chair might stop moving temporarily.</p>
<p>■ The power switch turns off when using the service outlet.</p> 	<ul style="list-style-type: none"> <li>■ The amount of current used is 7 A (230 V AC) or less.</li> <li>■ Has there been a short circuit in one of the devices connected to the service outlet?</li> </ul>	<ul style="list-style-type: none"> <li>■ The breaker function operates if the current used exceeds 7 A (230 V AC). Use an amount of current that does not exceed 7 A (230 V AC), and turn on the power switch again so that the chair will operate normally. (p. 22)</li> <li>■ Switch to using a different device and try turning on the power switch. If the power cannot be turned on when using a different device, contact your closest dealer or Takara Belmont.</li> </ul> <div style="border: 1px solid black; padding: 2px; width: fit-content; margin: 5px 0;">Breaker Function</div> <p>This is a protective function that prevents damage to devices due to using a current that exceeds the rated current value.</p>

## These are not malfunctions

<ul style="list-style-type: none"> <li>■ Abnormal sound at startup</li> <li>■ Sound when rotating the chair</li> </ul>	<ul style="list-style-type: none"> <li>■ Such sound is due to the internal hydraulic fluid being cold and is not a functional fault. It will readily stop.</li> <li>■ This is the sound of the steel balls rolling when the chair is rotated. The level of this sound varies depending on the environment where the chair is installed.</li> </ul>
--	--

If any of the problems described above are inspected and the chair does not work normally even after performing the recovery procedures, immediately stop using the chair, turn off the power, unplug the power plug, and contact your closest dealer or Takara Belmont.

# Daily Inspection Procedures

Perform the following inspection procedures in order to ensure that the chair can be used safely.

• Daily Inspection Procedures

Inspection Item	Inspection Procedures	Recovery Procedures if there is a Problem
<p><input type="checkbox"/> Check that the chair operates normally.</p>	<p><input type="checkbox"/> Turn on the power switch, and check if a double beep is emitted intermittently.</p> <p><input type="checkbox"/> Check that the chair moves normally to the preset positions by using the preset function.</p> <p><input type="checkbox"/> Check that the chair moves normally to the initial position (position for getting in or out of the chair) by using the auto-return switch.</p> <p><input type="checkbox"/> Check that the chair rises and lowers by using the UP/DOWN operation switches and pedal switches of the chair.</p> <p><input type="checkbox"/> Check that the chair backrest can be reclined and raised by using the backrest operation switch.</p> <p><input type="checkbox"/> Check that chair rotation can be locked and unlocked by using the rotation lock switch.</p> <p><input type="checkbox"/> Check that there is no wobbling or abnormal noise when operating the chair.</p>	<p><input type="checkbox"/> Turn off the power switch, and wait approximately five seconds before turning on the power switch again. If the alarm still sounds, the position detector might be faulty. Stop using the chair, turn off the power, unplug the power plug, and contact your closest dealer or Takara Belmont.</p> <p><input type="checkbox"/> Perform the procedures indicated in "(4) Using Preset Functions", "1. Using the preset function" under "How to Use" (p. 17). If the chair does not operate normally even after performing these procedures, stop using the chair, turn off the power, unplug the power plug, and contact your closest dealer or Takara Belmont.</p> <p><input type="checkbox"/> Perform the procedures indicated in "(4) Using Preset Functions", "2. Using the auto-return function" under "How to Use" (p. 18). If operation is still not normal, it might not be possible to safely get in and out of the chair. Stop using the chair, turn off the power, unplug the power plug, and contact your closest dealer or Takara Belmont.</p> <p><input type="checkbox"/> Perform the procedures indicated in "(2) Raising/Lowering the Chair" under "How to Use" (p. 14). If operation is still not normal, it might not be possible to safely get in and out of the chair. Stop using the chair, turn off the power, unplug the power plug, and contact your closest dealer or Takara Belmont.</p> <p><input type="checkbox"/> Perform the procedures indicated in "(3) Reclining/Raising the Backrest" under "How to Use" (p. 15). If operation is still not normal, it might not be possible to safely get in and out of the chair. Stop using the chair, turn off the power, unplug the power plug, and contact your closest dealer or Takara Belmont.</p> <p><input type="checkbox"/> Perform the procedures indicated in "(1) Guiding Customers", "1. Rotate the chair so that the customer can be easily seated on the chair" under "How to Use" (p. 12). If operation is still not normal, it might not be possible to safely get in and out of the chair. Stop using the chair, turn off the power, unplug the power plug, and contact your closest dealer or Takara Belmont.</p> <p><input type="checkbox"/> If there is any wobbling or abnormal noise when operating the chair, stop using the chair, turn off the power, unplug the power plug, and contact your closest dealer or Takara Belmont.</p>

# Daily Inspection Procedures

Inspection Item	Inspection Procedures	Recovery Procedures if there is a Problem
<input type="checkbox"/> Check that the chair operates normally.	<input type="checkbox"/> Check that the chair stops at the desired position for a fixed period and does not sink.	<input type="checkbox"/> If the chair does not stop for a fixed period and sinks, stop using the chair, turn off the power, unplug the power plug, and contact your closest dealer or Takara Belmont.
<input type="checkbox"/> Check that there are no abnormal odors emitted from the chair.	<input type="checkbox"/> Check that no abnormal odors or smoke is being emitted from the chair.	<input type="checkbox"/> Using the chair in such condition can result in abnormal operation or fire. Stop using the chair, turn off the power, unplug the power plug, and contact your closest dealer or Takara Belmont to inform of the abnormal situation.
<input type="checkbox"/> Check that no oil is leaking.	<input type="checkbox"/> Check that no oil has dripped on the top of the base or oil is not seeping from the pump cover.	<input type="checkbox"/> Oil might be leaking from hydraulic parts. Stop using the chair, turn off the power, unplug the power plug, and contact your closest dealer or Takara Belmont.

# Specifications

Model No.	AB-9500P/E	
Rated voltage	230 V AC	
Rated frequency	50 Hz	
Rated current	2.0 A	
Weight	175 kg (385 lb) AB-9500P	
Maximum load	166 kg (365 lb) AB-9500E	
Operating noise volume	1,350 N (135 kgf/300 lbf) 70 dB or less	
Usage environment	: Temperature	0 ~ 40°C
	Humidity	10 ~ 95%
	Air pressure	700 ~ 1060 hPa
Transportation / Storage environment	: Temperature	-20 ~ 70°C
	Humidity	10 ~ 95%
	Air pressure	700 ~ 1060 hPa

## ■ AB-9500P

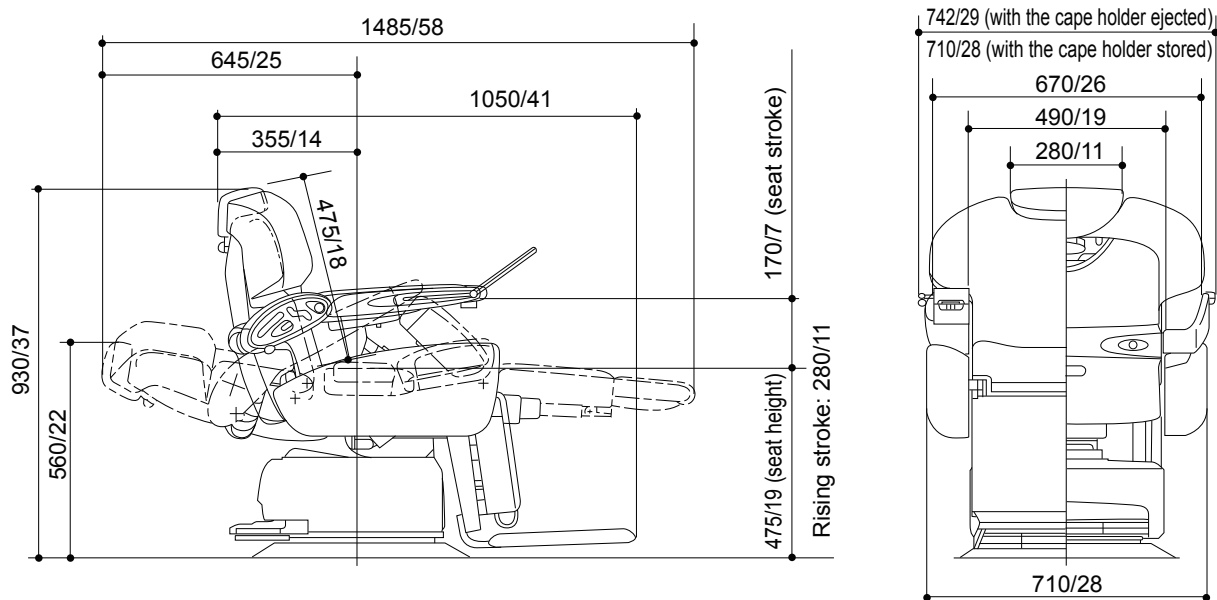

## ■ AB-9500E

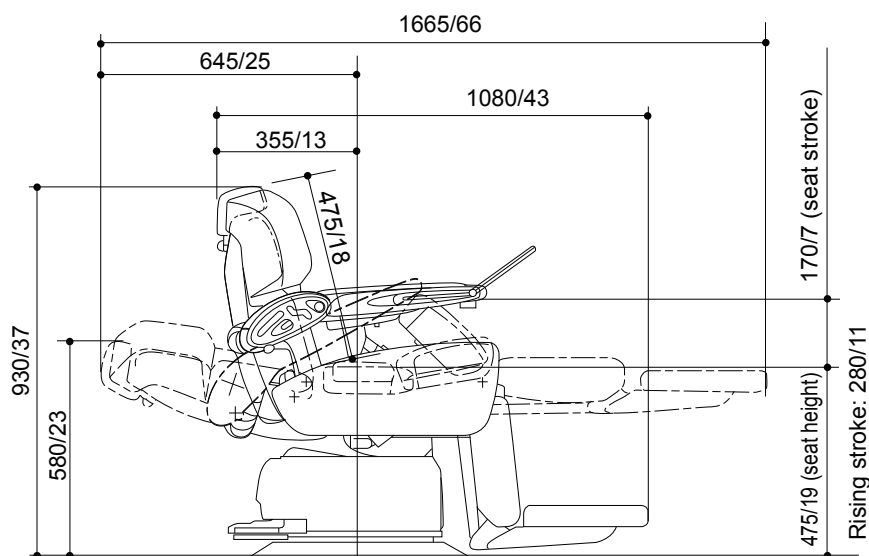

\* Dimensions and specifications are subject to change without notice due to design improvement. Seat standard values are indicated (Unit: mm/inch).

## Standard Period of Use

- The standard period of use of this chair is 10 years.
- The standard period of use is "an approximate standard period for which the chair can be safely used with no impediments to safety under the standard use conditions for each chair and while performing proper maintenance and inspection (including parts replacement)". This is not a warranty period. The length of the "standard period" differs depending on the use environment and frequency of use of the customer. For maintenance after the standard period of use, contact your closest dealer or Takara Belmont.

## Disposing of this Product

Dispose of this chair and replaced parts in a proper manner that complies with local laws and regulations.

## Declaration of Conformity

We hereby declare that the product listed below complies with the essential requirements of the EMC (electromagnetic compatibility) Directive:2014/30/EU, Low Voltage Directive:2014/35/EU, Machinery Directive: 2006/42/EC and RoHS Directive:2011/65/EU based on category 2 of Annex I.  
Product: BARBER CHAIR  
Model: MAXIM  
The product has been designed and manufactured in accordance with the European standards as the listed in the Declaration of Conformity.

**EU REPRESENTATIVE**

**TAKARA COMPANY EUROPE GmbH**  
Berner Strasse 18, 60437  
Frankfurt am Main, Germany  
Tel:+49 69 506878 0  
Fax:+49 69 506878 20

**MANUFACTURER**

**TAKARA  
BELMONT**



**TAKARA BELMONT CORPORATION**

2-1-1, Higashishinsaibashi, Chuo-ku, Osaka, 542-0083, Japan  
TEL: 81-6-6212-3523  
FAX: 81-6-6211-5745

Printed in Japan 2019-04  
BOOK NO.AFFX64EE  
Original instruction